

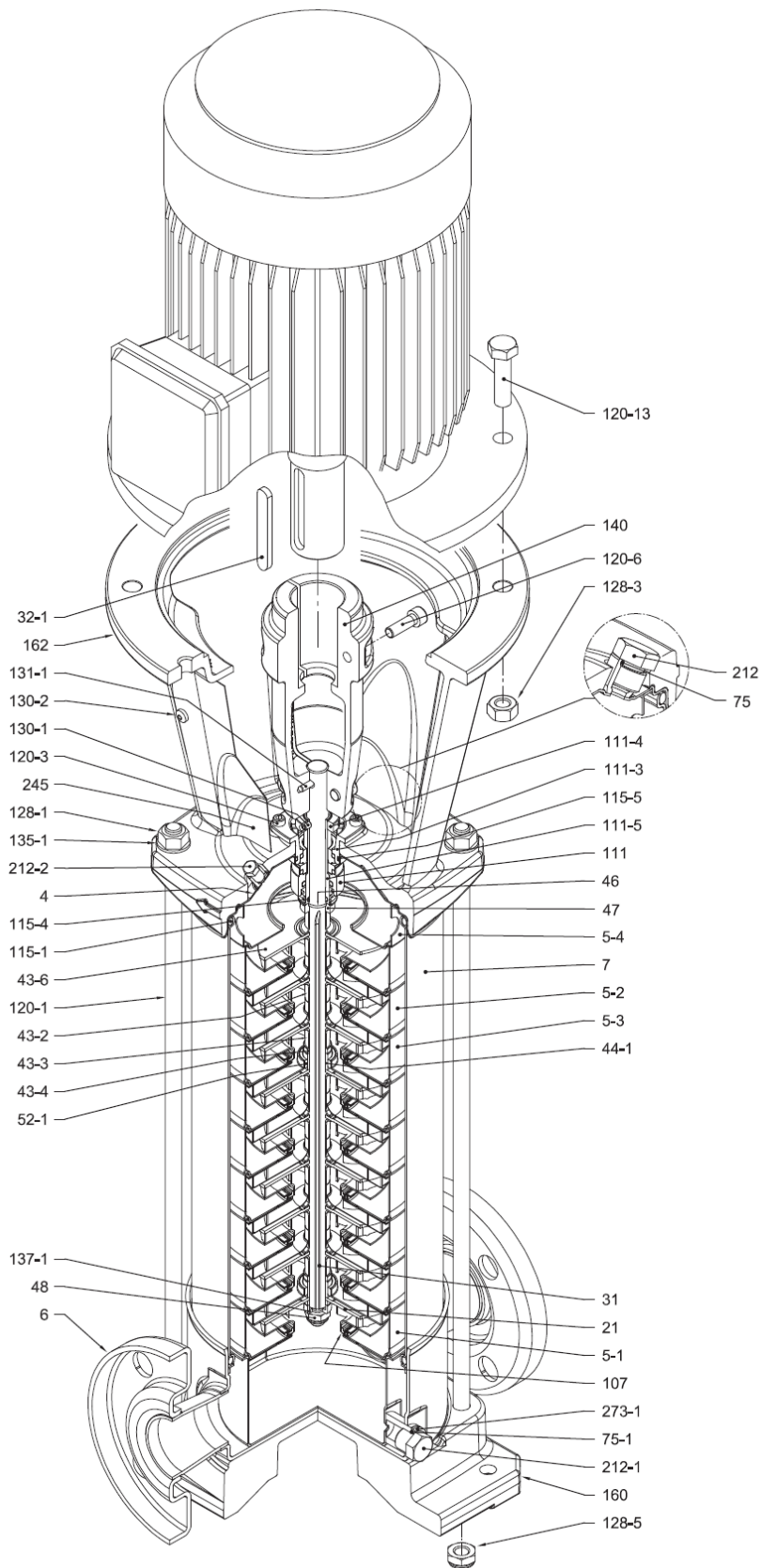

CV 20



Rundflansch / Round flange



CV 20

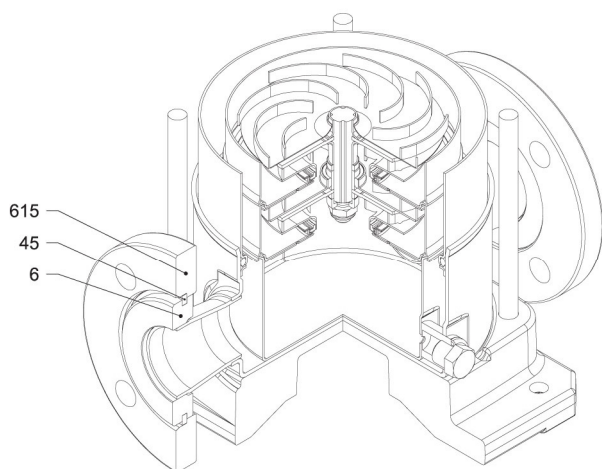

Losflansch / Loose round flange

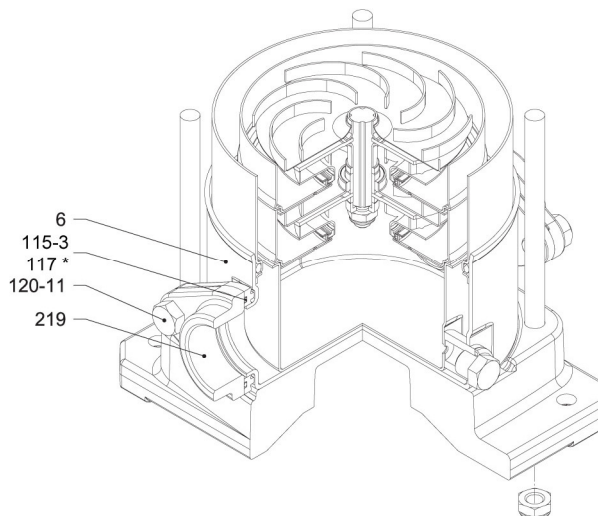

Ovalflansch / Oval flange

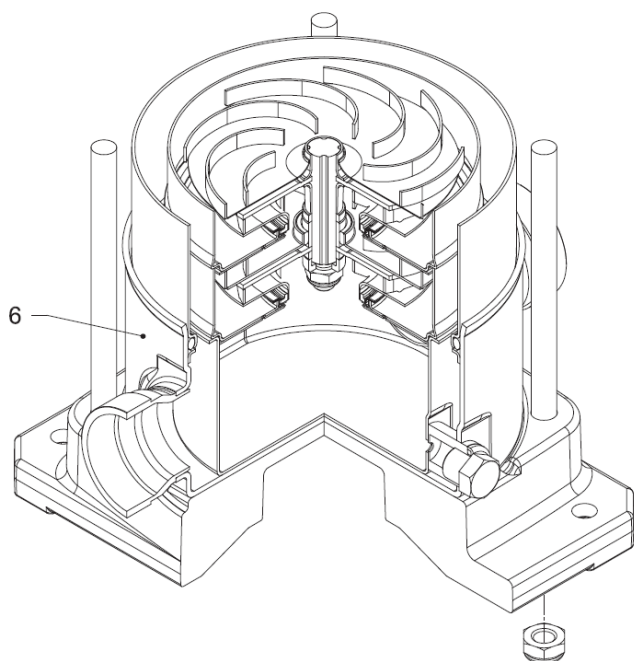

Victaulic

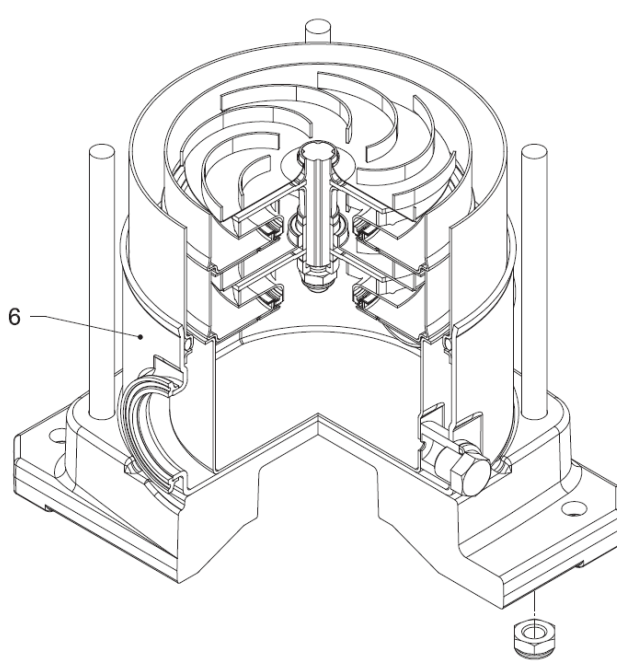

Clamp



CV 20

Teil-Nr. / Part no.	Benennung	Designation
4	Dichtungsträger	Casing cover
5-1	Eintrittsstufe	Suction casing
5-2	Stufengehäuse	Intermediate casing
5-3	Stufengehäuse mit Lager	Intermediate casing bearing
5-4	Austrittsstufe	Discharge casing
6	Pumpengehäuse	Bottom casing
7	Außengehäuse	Outer casing
21	Lauftrad	Impeller
31	Welle	Shaft
32-1	Passfeder	Key
43-2	Distanzring (Stufengehäuse)	Shaft sleeve (Intermediate)
43-3	Distanzring (Gleitlager)	Shaft sleeve (bearing)
44-1	Gleitlager (Welle)	Shaft sleeve bearing
45 *	Halbring	Flange holder
46	Spliring (Gleitringdichtung)	Ring (mechanical seal)
47	Sicherungsring	Ring holder
48	Lauftradmutter	Impeller nut
52-1	Gleitlagerbuchse	Bearing
75	O-Ring (Ablassschraube)	O-Ring (plug)
75-1	O-Ring (Ablassschraube)	O-Ring (plug)
107	Schleißring	Liner ring
111	Gleitringdichtung	Mechanical seal
111-3	Dichtungsträger (Cartridge)	Mechanical seal seat
111-4	Dichtungshalter	Seal holder
111-5	Distanzring (Cartridge)	Mechanical seal Cartridge
115-1	O-Ring (Außengehäuse)	O-Ring (Outer casing)
115-3 *	O-Ring	O-Ring

Teil-Nr. / Part no.	Benennung	Designation
115-4	O-Ring (Cartridge)	O-Ring (Cartridge sleeve)
115-5	O-Ring (Cartridge)	O-Ring (Cartridge sleeve)
117	Losflanschdichtung	Flange gasket
120-1	Zuganker	Tie-rod
120-3	Schraube	Screw
120-6	Schraube (Kupplung)	Screw (Coupling)
120-11	Schraube (Gegenflansch)	Screw (Counterflange)
120-13	Schraube (Motor)	Screw (Motor)
128-1	Mutter (Zuganker)	Nut (Tie-rod)
128-3	Mutter (Motor ab 5,5 kW)	Nut (motor up to 5,5 kW)
128-5 *	Mutter (Zuganker)	Nut (Tie-rod)
128-6	Mutter (Kupplung)	Nut (Coupling)
130-1	Schraube	Set screw
130-2	Schraube (Kupplungsschutz)	Screw (Coupling guard)
131-1	Zylinderstift	Pin of shaft
135-1	Unterlegscheibe	Washer
137-1	Spacer Lauftrad	Impeller spacer
140	Kupplung	Coupling
160 *	Grundplatte	Base
162	Motorträger	Motor bracket
212	Ablassschraube	Plug
212-1	Ablassschraube	Plug
212-2	Entlüftungsschraube	Venting plug
219	Gegenflansch	Counter flange
245	Kupplungsschutz	Coupling guard
273-1	Unterlegscheibe	Plug washer
615 *	Losflansch	Flange

* nur Edelstahl [Cr] / only Stainless steel [Cr]